

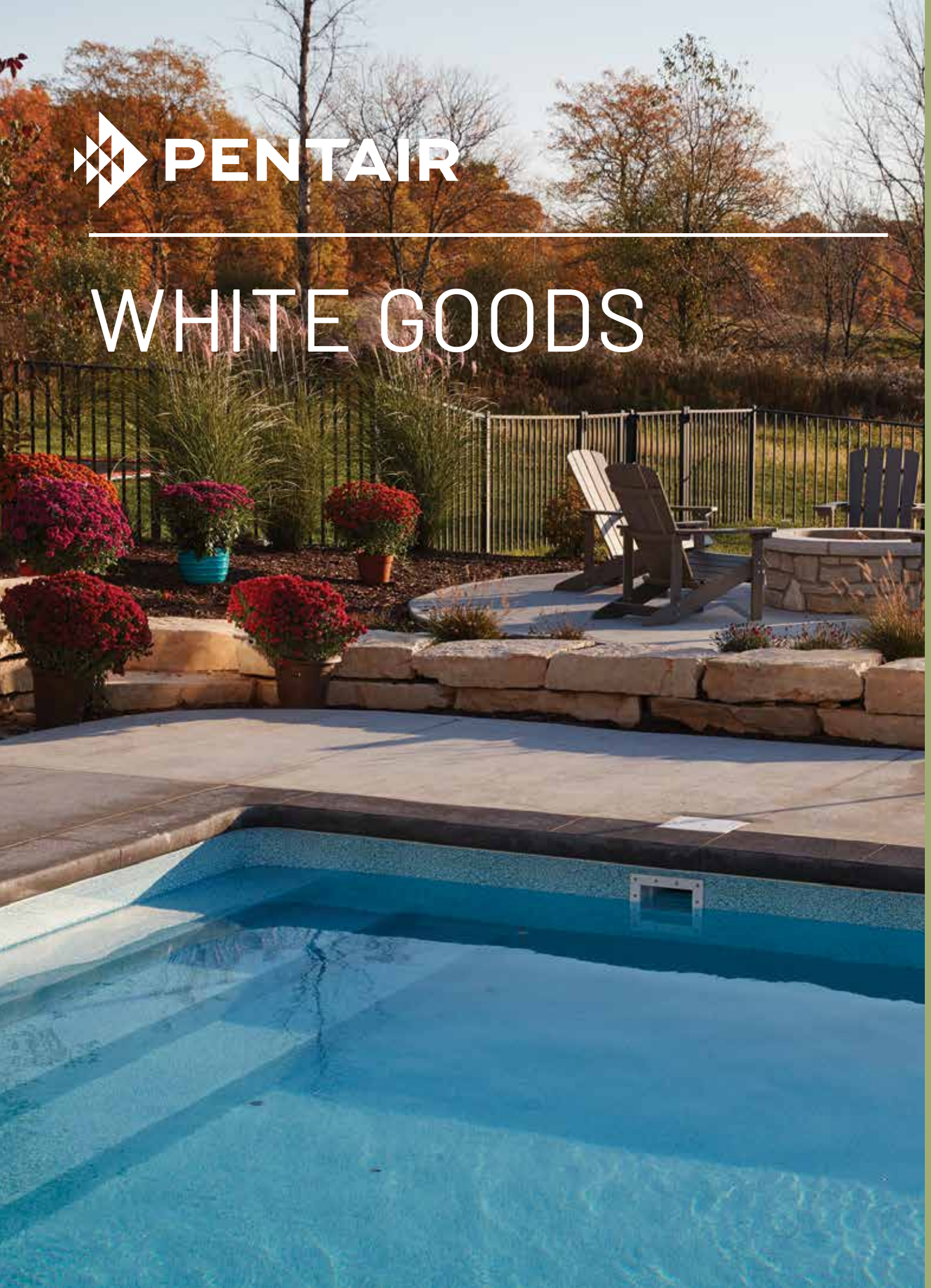

WHITE GOODS



ADMIRAL™ S15 AND S20 SKIMMERS

ADMIRAL SKIMMERS FOR POOLS AND SPAS



Admiral Skimmers

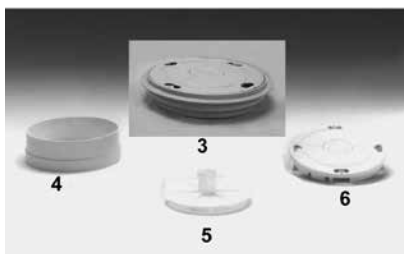

Admiral Skimmer Accessories

Admiral S15 Skimmers offer a variety of bases and throats for a wide variety of plumbing and construction requirements, configurations and materials. These skimmers have an innovative lock-down lid that can be personalized with custom logo disks. S15 Skimmers are injection molded of high strength ABS and are available with a flap weir for skimming action.

Admiral S20 Skimmers have a PVC reinforced twin port base. S20 may be purchased with equalizer for commercial and NSF applications or for when the second port is connected to the main drain. All models include the innovative lock down lid that can be personalized with custom logo disks and are available with a flap weir or the circular weir for superior skimming action.

Featured Highlights

- Admiral 15 Skimmers: High strength ABS body
- Admiral S20 Skimmers: Reinforced PVC base
- Slip FIPT, 1-1/2 inch or 2 inch
- Variety of throat lengths
- Easy to install
- Innovative lock down lid
- 1-1/2 inch and 2 inch ports
- Lid extension collars
- Flap weir or the circular weir
- Custom logo disk available

Ordering Information

Product	Description	Carton Qty.	Carton Wt. (Lbs.)
S15 SKIMMERS FOR CONCRETE CONSTRUCTION			
84120100	S15, circ. weir, 1-1/2 in., threaded	1	10
84120200	S15, circ. weir, 2 in., threaded	1	10
84900300	S15, flap weir, 1-1/2 in., threaded	1	10
S15 SKIMMERS FOR VINYL CONSTRUCTION			
84151500	S15, OM circ. weir, 1-1/2 in., threaded short throat	1	10
84141100	S15, circ. weir, 1-1/2 in., threaded short throat	1	10
S20 SKIMMERS FOR CONCRETE CONSTRUCTION			
84420405	S20, flap weir, no equalizer, 1-1/2 in. slip	1	10
84420500	S20, circ. weir, equalizer, 2 in. threaded, FIPT ¹	1	12
84420505	S20, circ. weir, equalizer, 2 in. slip ¹	1	12
84420530	S20, circ. weir, equalizer, 2 in. threaded, tan ¹	1	12
84420535	S20, circ. weir, equalizer, 2 in. slip, tan ¹	1	12
84420730	S20, circ. weir, 2 in. threaded, tan	1	10
84420735	S20, circ. weir, 2 in. slip, tan	1	10
84420600	S20, flap weir, equalizer, 2 in. threaded, FIPT ¹	1	12
84420605	S20, flap weir, equalizer, 2 in. slip ¹	1	12
84420630	S20, flap weir, equalizer, 2 in. threaded, tan ¹	1	12
84420635	S20, flap weir, equalizer, 2 in. slip, tan ¹	1	12
84420700	S20, circ. weir, no equalizer, 2 in. threaded, FIPT	1	10
84420705	S20, circ. weir, no equalizer, 2 in. slip	1	10
84420800	S20, flap weir, no equalizer, 2 in. threaded, FIPT	1	10
84420805	S20, flap weir, no equalizer, 2 in. slip	1	10
84420730	S20, circ. weir, 2 in. threaded, tan	1	10
84420735	S20, circ. weir, 2 in. slip, tan	1	10
S20 SKIMMERS FOR VINYL LINER POOLS			
84452200	S20S flap weir, equalizer, XLG std. 1-1/2 in. threaded, short throat 8-3/4 in. ¹	1	10
84472400	S20L flap weir, XLG std. 1-1/2 in. threaded, long throat 13 in.	1	10
S20 SKIMMERS FOR FIBERGLASS POOLS			
500023	S20, "WEDGE" flap weir, equalizer, 2 in. slip ¹	1	10

¹ NSF listed for commercial installation. Check valve 506162 must be purchased separately.

ADMIRAL™ S15 & S20 SKIMMERS (CONT'D)

506162	Equalizer check valve	1	0.25
85018000	Lid with ring seat, S15 & S20, 9 in. beige	1	1
85002300	Extension collar for ring seat, adjustable to 3 in.	1	0.50
85001900	Vacuum plate adapter, S15 & S20	1	0.50
85007400Z	Lock down lid for existing Admiral skimmers, white	1	0.50
85007411	Lock down lid for existing Admiral skimmers, black	1	0.50
85007413	Lock down lid for existing Admiral skimmers, gray	1	0.50
85007430	Lock down lid for existing Admiral skimmers, tan	1	0.50
85000400	Lid/collar set, white	1	0.50
85000411	Lid/collar set, black	1	0.50

Dimensions and Performance

ADMIRAL S20 SKIMMER PROFILE

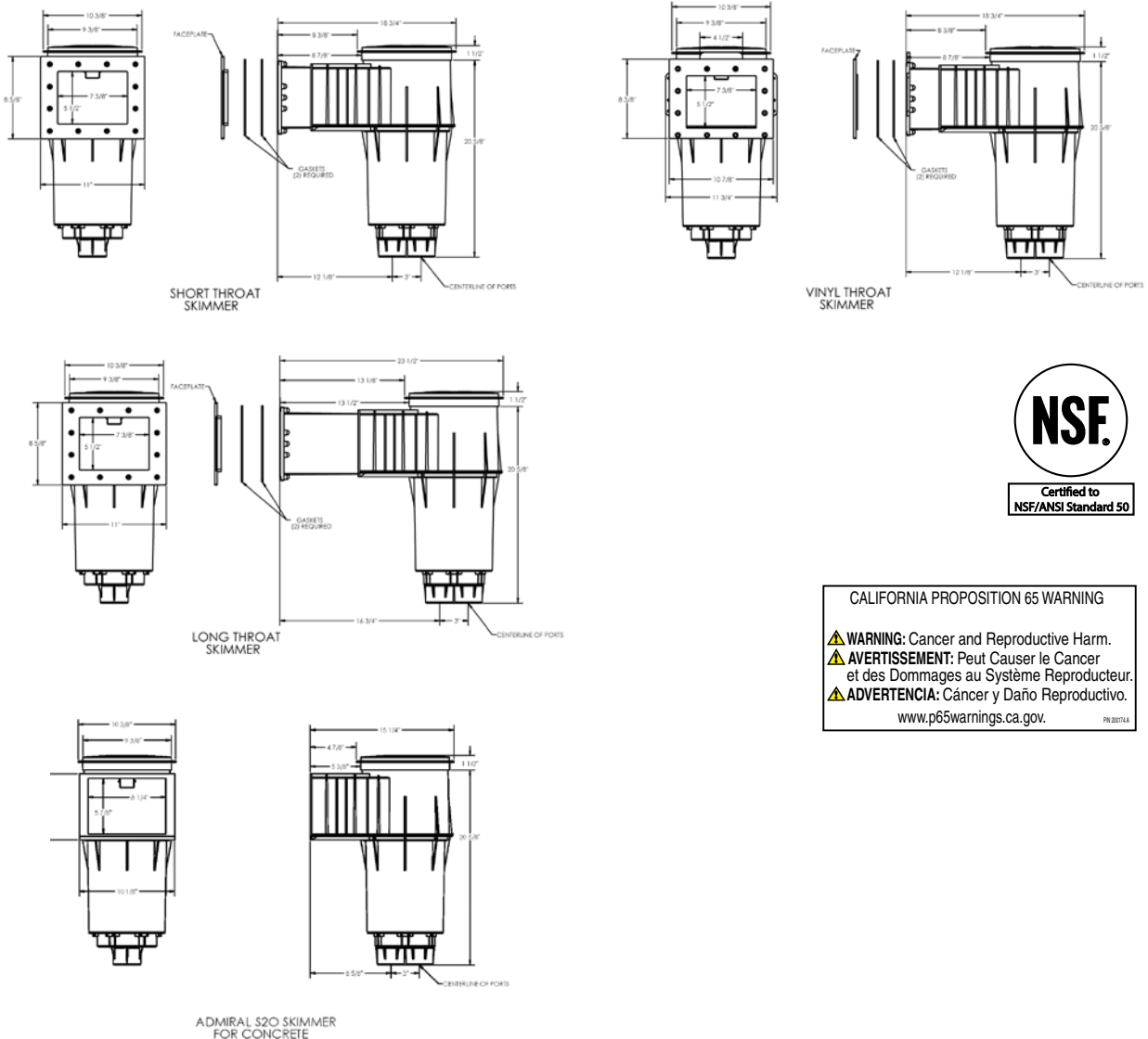

CALIFORNIA PROPOSITION 65 WARNING

⚠️ **WARNING:** Cancer and Reproductive Harm.
 ⚠️ **AVERTISSEMENT:** Peut Causer le Cancer et des Dommages au Système Reproducteur.
 ⚠️ **ADVERTENCIA:** Cáncer y Daño Reproductivo.
www.p65warnings.ca.gov

BERMUDA™ SKIMMERS

SKIMMERS FOR GUNITE POOLS, VINYL LINER AND FIBERGLASS POOLS

Featured Highlights

Choose among the following configurations:

- ABS or PVC
- White, black and tan colors available
- 1-1/2 in. or 2 in. slip or threaded ports
- Optional equalizer valve

Bermuda Skimmers feature a heavy-duty one-piece construction with sturdy external ribbing for superior strength. All Bermuda Skimmers for vinyl liner and fiberglass pools are made from ABS plastic.



Vinyl/Fiberglass Skimmer



Gunite Skimmer



Wide-mouth Vinyl/Fiberglass Skimmer

Dimensions and Performance

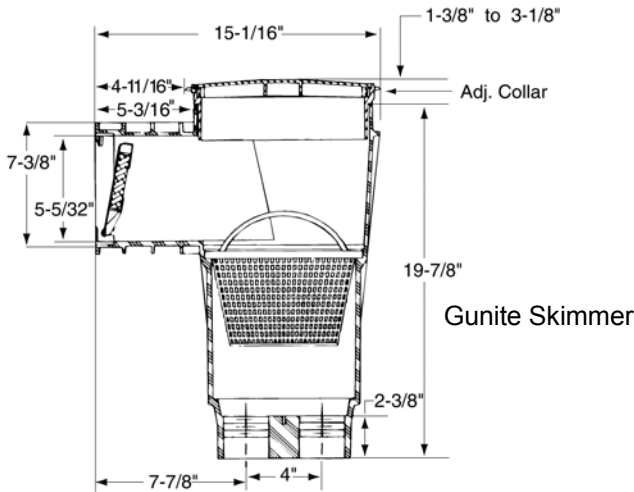

CALIFORNIA PROPOSITION 65 WARNING
 ⚠️ **WARNING:** Cancer and Reproductive Harm.
 ⚠️ **AVERTISSEMENT:** Peut Causer le Cancer et des Dommages au Système Reproducteur.
 ⚠️ **ADVERTENCIA:** Cáncer y Daño Reproductivo.
www.p65warnings.ca.gov P652014

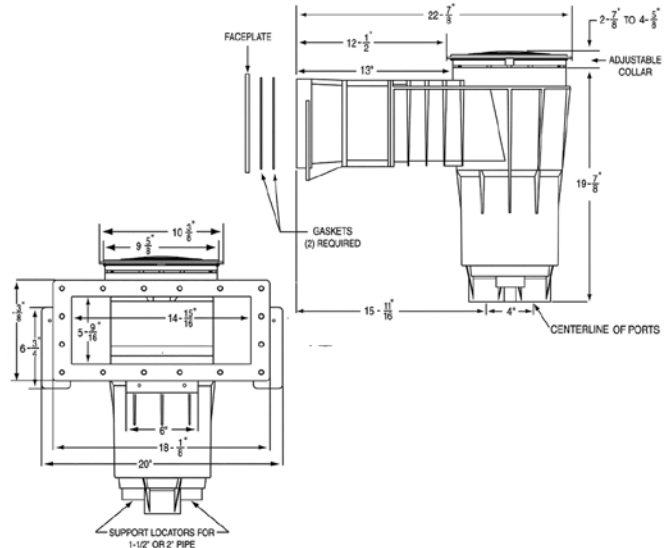
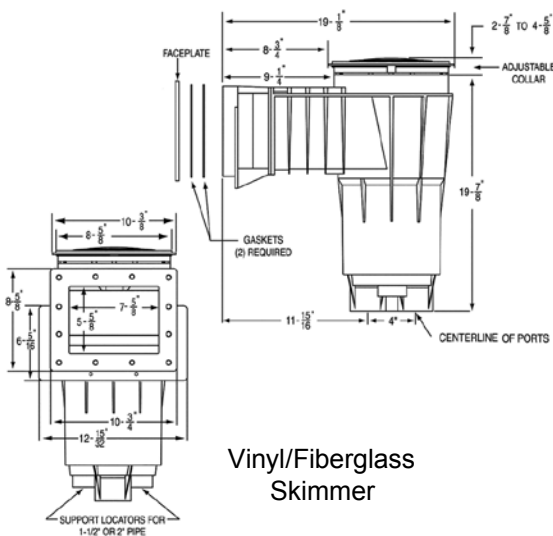

BERMUDA™ SKIMMERS (CONT'D)

Ordering Information



Product	Description	Material Type	Carton Qty.	Carton Wt. (Lbs.)
GUNITE SKIMMERS				
506300	2 in. Slip ports, white	PVC	1	10
506301	2 in. Threaded ports, white	PVC	1	10
506302	2 in. Slip ports, tan	PVC	1	10
506304	1-1/2 in. Slip ports, white	PVC	1	10
506361	2 in. Slip ports, white	ABS	1	10
506362	2 in. Threaded ports, white	ABS	1	10
506363	1-1/2 in. Slip ports, white	ABS	1	10
506364	1-1/2 in. Threaded ports, white	ABS	1	10
506365	2 in. Slip ports, black	ABS	1	10
GUNITE SKIMMERS WITH FLOAT VALVE ASSEMBLY				
506382	2 in. Slip ports, tan	ABS	1	10
506308	2 in. Slip ports with float valve, white	PVC	1	10
506309	2 in. Threaded ports with float valve, white	PVC	1	10
506310	2 in. Slip ports, tan	PVC	1	10
GUNITE SKIMMERS WITH FLOAT VALVE & EQUALIZER VALVE ASSEMBLY				
506370	2 in. slip ports, white ¹ (BKG)	PVC	1	10
506380	2 in. slip ports, white ¹ (ABKG)	ABS	1	10
506381	2 in. threaded ports, white ¹ (ABKG)	ABS	1	10
VINYL/FIBERGLASS SKIMMER				
506420	1-1/2 in. Slip ports, white	ABS	1	10
506421	1-1/2 in. Threaded ports, white	ABS	1	10
506480	1-1/2 in. Threaded ports, black	ABS	1	10
WIDE-MOUTH SKIMMER FOR VINYL LINER & FIBERGLASS POOLS				
506520	1-1/2 in. Slip ports, white	ABS	1	10
506521	1-1/2 in. Threaded ports, white	ABS	1	10
506581	1-1/2 in. Threaded ports, black	ABS	1	10

¹ NSF listed.



A



B



F



E

Item	Product	Description	Carton Wt. (Lbs.)
BERMUDA ACCESSORIES			
A	506160	Float valve assembly	1
B	506161	Vacuum plate/insert assembly, white	0.50
C	506162	Equalizer valve assembly	1.3
E	516253	Gunite extension collar, white, 3-1/8 in. length	0.20
E	516258	Gunite extension collar, tan, 3-1/8 in. length	0.60
E	516329	Gunite extension collar, black, 3-1/8 in. length	0.60
F	510327	Deck lid and collar assembly with screws, dark gray	1.3
F	510332	Deck lid, dark gray	0.50
F	516215	Deck lid, white	0.50
F	516216	Deck lid, tan	0.50
F	516254	Deck lid and collar assembly with screws, white	1.3
F	516261	Deck lid and collar assembly with screws, tan	1.3
F	516306	Deck lid, black	0.50
F	516328	Deck lid and collar assembly with screws, black	1.3

CALIFORNIA PROPOSITION 65 WARNING

⚠ **WARNING:** Cancer and Reproductive Harm.
 ⚠ **AVERTISSEMENT:** Peut Causer le Cancer et des Dommages au Système Reproducteur.
 ⚠ **ADVERTENCIA:** Cáncer y Daño Reproductivo.
www.p65warnings.ca.gov

See pages 593 for replacement parts.

U-3 SKIMMERS

SWIMQUIP INGROUND SKIMMERS



Ordering Information

Product	Description	Carton Qty.	Carton Wt. (Lbs.)
SKIMMERS FOR CONCRETE POOLS			
08650-1403	U-3 Skimmer White w/ White Lid & Frame, 2 in. NPT with 1-1/2 in. NPT Reducers; Incl. Float and Check Valve, Basket ¹	48	10
08650-3403	U-3 Skimmer Gray w/ Gray Lid & Frame, 2 in. NPT with 1-1/2 in. NPT Reducers; Incl. Float and Check Valve, Basket; NSF ¹	48	10
08650-3403E	U-3 Skimmer Gray, w/ Tan Lid & Frame, 2 in. NPT with 1-1/2 in. NPT Reducers; Incl. Float and Check Valve, Basket; NSF ¹	48	10
08650-2403	U-3 Skimmer White w/ Tan Lid & Frame, 2 in. NPT with 1-1/2 in. NPT Reducers; Incl. Float and Check Valve, Basket ¹	48	10
08650-1404	U-3 Skimmer White w/ White Lid & Frame, 2 in. Slip with 1-1/2 in. Slip Reducers; Incl. Float and Check Valve, Basket ¹	48	10
08650-3404	U-3 Skimmer Gray w/ Gray Lid & Frame, 2 in. Slip with 1-1/2 in. Slip Reducers; Incl. Float and Check Valve, Basket; NSF ¹	48	10
08650-3404E	U-3 Skimmer Gray, w/ Tan Lid & Frame, 2 in. Slip with 1-1/2 in. Slip Reducers; Incl. Float and Check Valve, Basket; NSF ¹	48	10
08650-2404	U-3 Skimmer White w/ Tan Lid & Frame, 2 in. Slip with 1-1/2 in. Slip Reducers; Incl. Float and Check Valve, Basket ¹	48	10
08650-4403	U-3 Skimmer White w/ White Lid & Frame, 2 in. NPT with 1-1/2 in. NPT Reducers; Incl. Basket w/o float	48	9
08650-6403	U-3 Skimmer Gray w/ Gray Lid & Frame, 2 in. NPT with 1-1/2 in. NPT Reducers; Incl. Basket w/o float	48	9
08650-6403E	U-3 Skimmer Gray, w/ Tan Lid & Frame, 2 in. NPT with 1-1/2 in. NPT Reducers; Incl. Basket w/o float	48	9
08650-5403	U-3 Skimmer White w/ Tan Lid & Frame, 2 in. NPT with 1-1/2 in. NPT Reducers; Incl. Basket w/o float	48	9
08650-4404	U-3 Skimmer White w/ White Lid & Frame, 2 in. Slip with 1-1/2 in. Slip Reducers; Incl. Basket w/o float	48	9
08650-6404	U-3 Skimmer Gray w/ Gray Lid & Frame, 2 in. Slip with 1-1/2 in. Slip Reducers; Incl. Basket w/o float	48	9
08650-6404E	U-3 Skimmer Gray w/ Tan Lid & Frame, 2 in. Slip with 1-1/2 in. Slip Reducers; Incl. Basket w/o float	48	9
08650-5404	U-3 Skimmer White w/ Tan Lid & Frame, 2 in. Slip with 1-1/2 in. Slip Reducers; Incl. Basket w/o float	48	9
SKIMMERS FOR VINYL POOLS			
09655-1403	Vinyl Skimmer – White; 2 in. NPT with 1-1/2 in. NPT Reducers	32	10
09655-1404	Vinyl Skimmer – White; 2 in. Slip with 1-1/2 in. Slip Reducers	32	10
09655-2403	Vinyl Skimmer – White w/ Tan Lid & Frame; 2 in. NPT with 1-1/2 in. NPT Reducers	32	10
09655-2404	Vinyl Skimmer – White w/ Tan Lid & Frame; 2 in. Slip with 1-1/2 in. Slip Reducers	32	10
09655-0010	Skimmer Mount Space Block (for vinyl pools only)	32	0.25



¹ NSF Certified. Only skimmers with Float Valve assemblies are NSF approved.

Note: All U-3 Skimmers are made with high strength ABS plastic.

CALIFORNIA PROPOSITION 65 WARNING

⚠ **WARNING:** Cancer and Reproductive Harm.
 ⚠ **AVERTISSEMENT:** Peut Causer le Cancer et des Dommages au Système Reproducteur.
 ⚠ **ADVERTENCIA:** Cáncer y Daño Reproductivo.

www.p65warnings.ca.gov. P8 2011/14

U-3 SKIMMERS (CONT'D)

Dimensions and Performance

U3 Skimmer for concrete

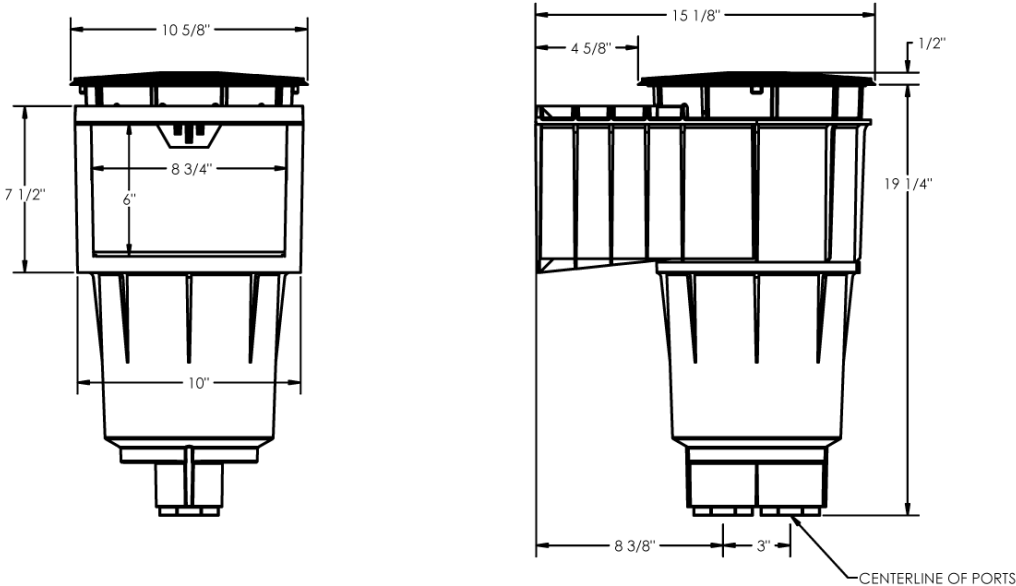

U3 Skimmer for vinyl

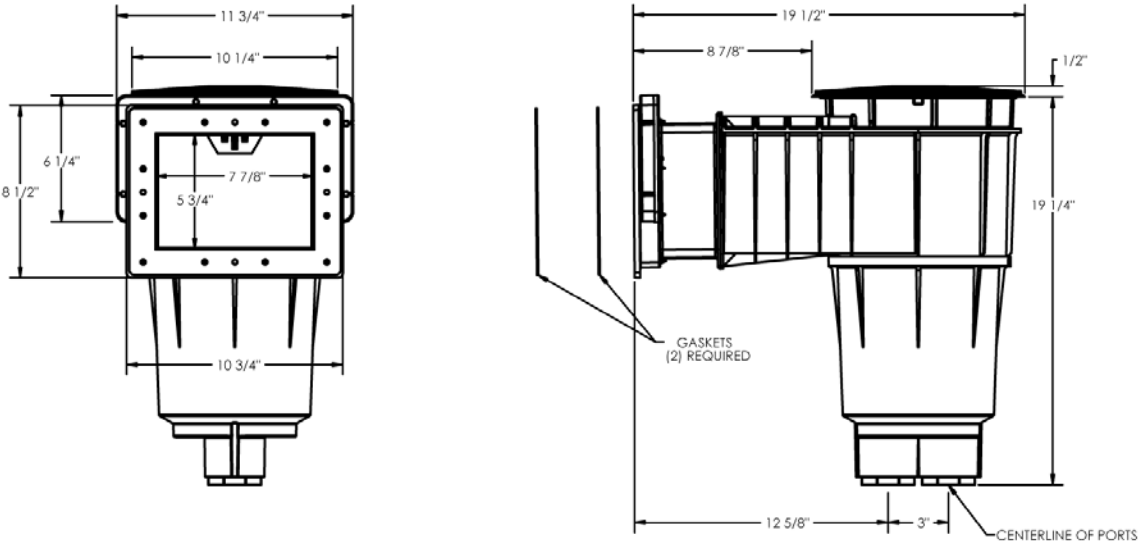

See page 594 for replacement parts.

QUIKSKIM VENTURI POWERED COMPLETE SKIMMERS



QuikSkim Black Body,
Black Ring Lid, w/ Foam



Optional Bonding Lug

Featured Highlights

- Uses existing return water to create stronger skimming-action
- Anti-entrapment design offers reassurance for you and your family
- Durable housing is available in multiple colors
- Available for concrete, vinyl, and fiberglass pools

Through venturi-powered skimming, natural water pressure from your pool creates a stronger vacuum to clear more debris than a standard skimmer, while eliminating the need for pump suction. Not only is this process energy efficient, it also provides the most effective surface skimming available.

Ordering Information

Pentair Item #	With Lug	Product Name & Description
QUIKSKIM COMPLETE WITH PROTECTA FOAM		
505107	504107	QuikSkim White Body, Tan Ring Lid, w/ Foam
505101	504101	QuikSkim White Body, White Ring Lid, w/ Foam
505102	504102	QuikSkim White Body, Gray Ring Lid, w/ Foam
505104	504104	QuikSkim White Body, Black Ring Lid, w/ Foam
505307	504307	QuikSkim Gray Body, Tan Ring Lid, w/ Foam
505301	504301	QuikSkim Gray Body, White Ring Lid, w/ Foam
505302	504302	QuikSkim Gray Body, Gray Ring Lid, w/ Foam
505304	504304	QuikSkim Gray Body, Black Ring Lid, w/ Foam
505207	504007	QuikSkim Black Body, Tan Ring Lid, w/ Foam
505201	504201	QuikSkim Black Body, White Ring Lid, w/ Foam
505202	504202	QuikSkim Black Body, Gray Ring Lid, w/ Foam
505204	504204	QuikSkim Black Body, Black Ring Lid, w/ Foam

CALIFORNIA PROPOSITION 65 WARNING
 ⚠️ **WARNING:** Cancer and Reproductive Harm.
 ⚠️ **AVERTISSEMENT:** Peut Causer le Cancer et des Dommages au Système Reproducteur.
 ⚠️ **ADVERTENCIA:** Cáncer y Daño Reproductivo.
www.p65warnings.ca.gov P652013A

QUIKSKIM VENTURI POWERED (CONT'D)

COMPLETE SKIMMERS

Pentair Item #	With Lug	Product Name & Description
QUIKSKIM COMPLETE WITHOUT PROTECTA		
501107	503107	QuickSkim, White Body, Tan Ring Lid
501101	503101	QuickSkim, White Body, White Ring Lid
501102	503102	QuickSkim, White Body, Gray Ring Lid
501104	500828	QuickSkim, White Body, Black Ring Lid
501307	503307	QuickSkim, Gray Body, Tan Ring Lid
501301	503301	QuickSkim, Gray Body, White Ring Lid
501302	500829	QuickSkim, Gray Body, Gray Ring Lid
501304	503304	QuickSkim, Gray Body, Black Ring Lid
501207	500830	QuickSkim, Black Body, Tan Ring Lid
501201	503200	QuickSkim, Black Body, White Ring Lid
500822	503002	QuickSkim, Black Body, Gray Ring Lid
501204	503000	QuickSkim, Black Body, Black Ring Lid
QUIKSKIM NO LID OR RING		
501110	503110	QuikSkim White Body, No Lid or Ring
500823	503310	QuikSkim Gray Body, No Lid or Ring
501210	503210	QuikSkim Black Body, No Lid or Ring
QUIKSKIM COMPLETE WITH PROTECTA NO LID OR RING		
505110	504110	QS w/ Protecta, White Body, No Lid or Ring
505310	504310	QS w/ Protecta, Gray Body, No Lid or Ring
505210	504010	QS w/ Protecta, Black Body, No Lid or Ring
QUIKSKIM VINYL		
501127	–	QuikSkim Vinyl White Body, Tan Ring Lid
501121	–	QuikSkim Vinyl White Body, White Ring Lid
501123	–	QuikSkim Vinyl White Body, Dark Gray Ring Lid
QUIKSKIM FIBERGLASS		
517337	–	QS Fiberglass Dark Gray Body, Tan Ring Lid
517333	–	QS Fiberglass Dark Gray Body, Dark Gray Ring Lid
501231	–	QS Fiberglass Dark Gray Body, White Ring Lid
510137	–	QS Fiberglass White Body, Tan Ring Lid
501131	–	QS Fiberglass White Body, White Ring Lid
501133	–	QS Fiberglass White Body, Dark Gray Ring Lid
518303	–	QS Fiberglass Square Frame Dark Gray
518007	–	QS Fiberglass Square Frame Tan
518101	–	QS Fiberglass Square Frame White

See page 148 for replacement parts.



See page 147 for the QuikSkim Ultra Venturi Powered Complete Skimmers.

REPLACEMENT SKIMMER LIDS WITH AND WITHOUT THERMOMETERS



Skimmer Lids with Thermometers

Skimmer thermometers eliminate misplacement, theft and breakage problems sometimes seen with floating thermometers. The hermetically sealed face is built for strength and weather resistance. The outside temperature will not affect the performance of the thermometer.

Featured Highlights

- Lids are available in 3 colors to blend with the pool environment
- Available to fit Pentair Aquatic Systems and other popular skimmer brands

CALIFORNIA PROPOSITION 65 WARNING

⚠ **WARNING:** Cancer and Reproductive Harm.
 ⚠ **AVERTISSEMENT:** Peut Causer le Cancer et des Dommages au Système Reproducteur.
 ⚠ **ADVERTENCIA:** Cáncer y Daño Reproductivo.
www.p65warnings.ca.gov

Ordering Information

Product	Description	Carton Qty.	Carton Wt. (Lbs.)
SKIMMER LIDS WITH THERMOMETER			
L1	SwimQuip, Swimrite, Jacuzzi® (New Style), Hayward®, 9-7/8 in., white	1	3/4
L1B	SwimQuip, Swimrite, Jacuzzi (New Style), Hayward, 9-7/8 in., almond	1	3/4
L1G	SwimQuip, Swimrite, Jacuzzi (New Style), Hayward, 9-7/8 in., gray	1	3/4
L2	Baker Hydro®, 9-7/8 in., white	1	3/4
L3	Hayward, Square, 10 in. x 10 in., white	1	3/4
L4B	Pentair Aquatic Systems, 9-3/16 in. round, almond	1	3/4
L4G	Pentair Aquatic Systems, 9-3/16 in. round, gray	1	3/4
L4W	Pentair Aquatic Systems, 9-3/16 in. round, white	1	3/4
L5	Pentair Aquatic Systems, (Old Style), 8-3/8 in., white	1	3/4
L6B	Pentair Aquatic Systems, Bermuda, 9-1/4 in., almond	1	3/4
L6G	Pentair Aquatic Systems, Bermuda, 9-1/4 in., gray	1	3/4
L6W	Pentair Aquatic Systems, Bermuda, 9-1/4 in., white	1	3/4
SKIMMER LIDS WITHOUT THERMOMETER			
L1RW	SwimQuip, Swimrite, Jacuzzi, Hayward (New Style), 9-7/8 in., white	1	3/4
L1RG	SwimQuip, Swimrite, Jacuzzi, Hayward (New Style), 9-7/8 in., gray	1	3/4
L1RB	SwimQuip, Swimrite, Jacuzzi, Hayward (New Style), 9-7/8 in., almond	1	3/4
L2R	Baker, Hydro, 9-7/8 in., white	1	3/4
L4RW	American Products, 9-3/16 in. round, white	1	3/4
L4RG	American Products, 9-3/16 in. round, gray	1	3/4
L4RB	American Products, 9-3/16 in. round, almond	1	3/4
L5R	Pentair Aquatic Systems (Old Style), 8-3/8 in., white	1	3/4
L6RW	Pentair Aquatic Systems, Bermuda, 9-1/4, white	1	3/4
L6RG	Pentair Aquatic Systems, Bermuda, 9-1/4, gray	1	3/4
L6RB	Pentair Aquatic Systems, Bermuda, 9-1/4, almond	1	3/4

Jacuzzi® is a registered trademark of Jacuzzi, Inc.; Hayward® is a registered trademark of Hayward Industries, Inc.; Baker Hydro® is a registered trademark of Waterco USA DBA Baker Hydro Corp.

GUTTER DRAINS

DRAINS AND FITTINGS

Featured Highlights

Pentair gutter drains come with an extra deep socket connection

CALIFORNIA PROPOSITION 65 WARNING
 ⚠️ **WARNING:** Cancer and Reproductive Harm.
 ⚠️ **AVERTISSEMENT:** Peut Causer le Cancer et des Dommages au Système Reproducteur.
 ⚠️ **ADVERTENCIA:** Cáncer y Daño Reproductivo.
 www.p65warnings.ca.gov. PK2017A



540064



542038



542039

Ordering Information

Product	Description	Flow Rate (GPM)	Open Area (Sq. In.)	Carton Qty.
GUTTER DRAINS				
540063	2 in. x 4 in. gutter drain & grate, white	14.5 @ 1-1/2 ft./sec.	3.09	50
540064	2 in. x 4 in. gutter drain & grate, black	14.5 @ 1-1/2 ft./sec.	3.09	50
540065	2 in. x 4 in. gutter drain & grate, dark gray	14.5 @ 1-1/2 ft./sec.	3.09	50
542038	2 in. x 4 in. 3-bar frame & grate, white	8.0 @ 1-1/2 ft./sec.	1.71	500
542039	2-1/2 in. x 6 in. gutter drain & grate, white	22.5 @ 1-1/2 ft./sec.	4.81	24
542146	2 in. x 4 in. grate (hi-style), white	14.5 @ 1-1/2 ft./sec.	3.09	500
552511	2 in. x 4 in. grate (fits 540063, 542037)	14.5 @ 1-1/2 ft./sec.	3.09	500

Dimensions and Performance

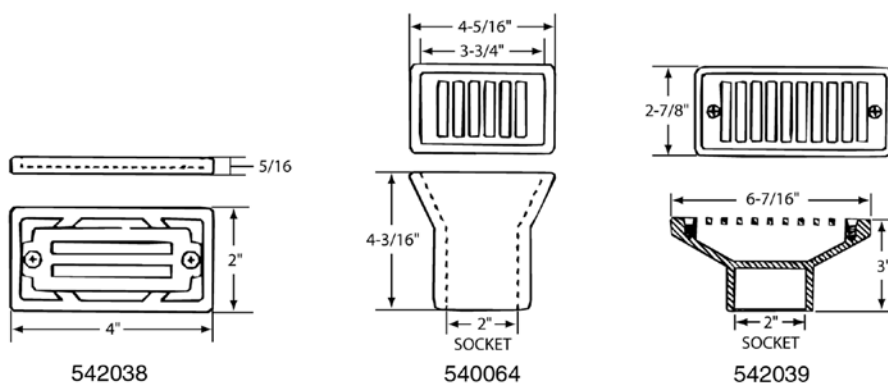

STARGUARD® MAIN DRAINS

MAIN DRAIN FRAME AND GRATE

StarGuard Main Drains comply with provisions of the ANSI/APSP/ICC-16 2017 standard and the Virginia Graeme Baker Pool and Spa Safety Act. High quality StarGuard main drains are available in white, black, gray, and dark gray as well as a variety of configurations to fit most residential inground pool or spa installations. StarGuard main drains have 15.35 square inches of open area for water flow and allow flow rates up to 72 GPM at 1-1/2 ft./sec.

Featured Highlights

- Available in Multiple Colors
- Compliant with the Virginia Graeme Baker Act

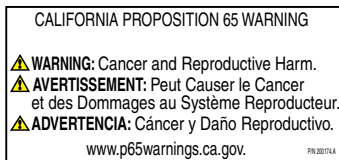

Ordering Information

Product	Description	Flow Rate Floor (GPM)	Flow Rate Wall (GPM)	Open Area (Sq. In.)
8 IN. STARGUARD COVER WITH LONG RING				
500108	8 in. StarGuard cover w/ long ring (single), white	136	88	15.35
500100	8 in. StarGuard cover w/ long ring (single), black	136	88	15.35
500101	8 in. StarGuard cover w/ long ring (single), dark gray	136	88	15.35
500102	8 in. StarGuard cover w/ long ring (single), gray	136	88	15.35
500140	8 in. StarGuard cover w/ long ring (2 pack), white	136	88	15.35
500141	8 in. StarGuard cover w/ long ring (2 pack), black	136	88	15.35
500142	8 in. StarGuard cover w/ long ring (2 pack), dark gray	136	88	15.35
500143	8 in. StarGuard cover w/ long ring (2 pack), gray	136	88	15.35
8 IN. STARGUARD COVER WITH SHORT RING AND COVER				
500103	8 in. StarGuard cover w/ short ring (single), white	136	88	15.35
500104	8 in. StarGuard cover w/ short ring (single), black	136	88	15.35
500105	8 in. StarGuard cover w/ short ring (single), dark gray	136	88	15.35
500106	8 in. StarGuard cover w/ short ring (single), gray	136	88	15.35
500144	8 in. StarGuard cover w/ short ring (2 pack), white	136	88	15.35
500145	8 in. StarGuard cover w/ short ring (2 pack), black	136	88	15.35
500146	8 in. StarGuard cover w/ short ring (2 pack), dark gray	136	88	15.35
500147	8 in. StarGuard cover w/ short ring (2 pack), gray	136	88	15.35
8 IN. STARGUARD DRAIN WITH 2 IN. SIDE AND 1-1/2 IN. BOTTOM PORTS ABS SUMP WITH RING AND COVER				
500110	8 in. StarGuard drain w/ 2 in. side & 1-1/2 in. bottom ports ABS sump w/ ring & cover (2 pack), white	136	88	15.35
500111	8 in. StarGuard drain w/ 2 in. side & 1-1/2 in. bottom ports ABS sump w/ ring & cover (2 pack), black	136	88	15.35
500113	8 in. StarGuard drain w/ 2 in. side & 1-1/2 in. bottom ports ABS sump w/ ring & cover (2 pack), dark gray	136	88	15.35
500114	8 in. StarGuard drain w/ 2 in. side & 1-1/2 in. bottom ports ABS sump w/ ring & cover (2 pack), gray	136	88	15.35

STARGUARD® MAIN DRAINS (CONT'D)

Product	Description	Flow Rate Floor (GPM)	Flow Rate Wall (GPM)	Open Area (Sq. In.)
8 IN. STARGUARD DRAIN WITH 2 IN. SIDE PORT ABS SUMP WITH RING AND COVER				
500115	8 in. StarGuard drain w/ 2 in. side port ABS sump w/ ring & cover (2 pack), white	136	88	15.35
500116	8 in. StarGuard drain w/ 2 in. side port ABS sump w/ ring & cover (2 pack), black	136	88	15.35
500117	8 in. StarGuard drain w/ 2 in. side port ABS sump w/ ring & cover (2 pack), dark gray	136	88	15.35
500118	8 in. StarGuard drain w/ 2 in. side port ABS sump w/ ring & cover (2 pack), gray	136	88	15.35
8 IN. STARGUARD DRAIN WITH DUAL 2 IN. BOTTOM PORTS ABS SUMP AND COVER				
500120	8 in. StarGuard drain w/ dual 2 in. bottom ports ABS sump & cover (2 pack), white	136	88	15.35
500121	8 in. StarGuard drain w/ dual 2 in. bottom ports ABS sump & cover (2 pack), black	136	88	15.35
500122	8 in. StarGuard drain w/ dual 2 in. bottom ports ABS sump & cover (2 pack), dark gray	136	88	15.35
500123	8 in. StarGuard drain w/ dual 2 in. bottom ports ABS sump & cover (2 pack), gray	136	88	15.35
8 IN. STARGUARD DRAIN WITH 2 IN. SIDE AND 1-1/2 IN. BOTTOM VINYL LINER ABS SUMP				
500130	8 in. StarGuard drain w/ 2 in. side & 1-1/2 in. bottom vinyl liner ABS sump (2 pack), white	136	88	15.35



500108
8 in. StarGuard cover
w/ long ring



500103
8 in. StarGuard cover
w/ short ring



500110
8 in. StarGuard drain w/ 2 in.
side & 1-1/2 in. bottom ports ABS
sump w/ ring & cover



500115
8 in. StarGuard drain
w/ 2 in. side port ABS
sump w/ ring & cover



500120
8 in. StarGuard drain w/
dual 2 in. bottom ports
ABS sump & cover



500130
8 in. StarGuard drain w/ 2
in. side & 1-1/2 in. bottom
vinyl liner ABS sump

See page 598 for replacement parts.

AVSC® HEAVY DEBRIS REMOVAL DRAIN

COMPLETE DRAINS



AVSC Single Standard Top Channel Drain White



AVSC Single Suction Pebble Top Drain White



AVSC Vinyl Single Suction White

Featured Highlights

- Available in single and dual-inlet models
- Easy installation, including construction cover
- Perfect for pools, spas, and water features
- Available with a Pebble Top Lid



AVSC Dual Standard Top Channel Drain White



AVSC Dual Suction Pebble Top Drain White



AVSC Vinyl Dual Suction White



AVSC Vinyl Dual with Hydro White

The AVSC drain is a heavy debris removal drain in an unblockable package. The AVSC drain conforms to all current ANSI, NSF and VGB anti-entrapment standards, and boasts one of the highest flow rates of any debris removal drain on the market.

Available in a both dual or single port models (accepting both 2.5" and 3" pipe) the AVSC comes in a wide variety of colors. In addition, an optional fillable lid is available to allow the drain to seamlessly blend into the surrounding finish of the pool.

Ordering Information

Pentair Item #	Product Name & Description
AVSC SINGLE SUCTION STANDARD TOP DRAIN	
285001	AVSC Single Standard Top Channel Drain White
285003	AVSC Single Standard Top Channel Drain Dark Gray
285004	AVSC Single Standard Top Channel Drain Black
285006	AVSC Single Standard Top Channel Drain Dark Blue
285005	AVSC Single Standard Top Channel Drain Euro Blue
285008	AVSC Single Standard Top Channel Drain Gold
285002	AVSC Single Standard Top Channel Drain Light Gray

CALIFORNIA PROPOSITION 65 WARNING

⚠️ **WARNING:** Cancer and Reproductive Harm.
 ⚠️ **AVERTISSEMENT:** Peut Causer le Cancer et des Dommages au Système Reproducteur.
 ⚠️ **ADVERTENCIA:** Cáncer y Daño Reproductivo.

www.p65warnings.ca.gov. PA62017A

AVSC® HEAVY DEBRIS REMOVAL DRAIN (CONT'D)

COMPLETE DRAINS

Pentair Item #	Product Name & Description
AVSC DUAL SUCTION STANDARD TOP DRAIN	
286101	AVSC Dual Standard Top Channel Drain White
286123	AVSC Dual Standard Top Channel Drain Dark Gray
286114	AVSC Dual Standard Top Channel Drain Black
286136	AVSC Dual Standard Top Channel Drain Dark Blue
286125	AVSC Dual Standard Top Channel Drain Euro Blue
290208	AVSC Dual Standard Top Channel Drain Gold
286102	AVSC Dual Standard Top Channel Drain Light Gray
AVSC SINGLE SUCTION PEBBLE TOP DRAIN	
288101	AVSC Single Pebble Top Channel Drain White
288103	AVSC Single Pebble Top Channel Drain Dark Gray
288104	AVSC Single Pebble Top Channel Drain Black
288106	AVSC Single Pebble Top Channel Drain Dark Blue
298235	AVSC Single Pebble Top Channel Drain Euro Blue
288108	AVSC Single Pebble Top Channel Drain Gold
288102	AVSC Single Pebble Top Channel Drain Light Gray
AVSC DUAL SUCTION PEBBLE TOP DRAIN	
289101	AVSC Dual Pebble Top Channel Drain White
289103	AVSC Dual Pebble Top Channel Drain Dark Gray
289104	AVSC Dual Pebble Top Channel Drain Black
289106	AVSC Dual Pebble Top Channel Drain Dark Blue
296205	AVSC Dual Pebble Top Channel Drain Euro Blue
289108	AVSC Dual Pebble Top Channel Drain Gold
289102	AVSC Dual Pebble Top Channel Drain Light Gray
VINYL AVSC SINGLE DRAIN	
284001	AVSC Vinyl Single White
284306	AVSC Vinyl Single Dark Blue
284002	AVSC Vinyl Single Light Gray
VINYL AVSC DUAL DRAIN	
284161	AVSC Vinyl Dual White
284006	AVSC Vinyl Dual Dark Blue
284202	AVSC Vinyl Dual Light Gray
VINYL AVSC SINGLE DRAIN WITH HYDRO STAT	
284071	AVSC Vinyl Single with Hydro White
284076	AVSC Vinyl Single with Hydro Dark Blue
284272	AVSC Vinyl Single with Hydro Light Gray
VINYL AVSC DUAL DRAIN WITH HYDRO STAT	
284171	AVSC Vinyl Dual with Hydro White
294076	AVSC Vinyl Dual with Hydro Dark Blue
284072	AVSC Vinyl Dual with Hydro Light Gray

POOL SPECIALTY FITTINGS

Pentair plumbing unions are available in a wide variety of configurations. Specialty fittings such as the snap lock wall fitting, anchor cup and rope hooks and the molded recessed steps are designed for ease of installation. Deck valve lid and ring allow for access to under deck valves and fittings. These fittings are manufactured to Pentair's high standards.

CALIFORNIA PROPOSITION 65 WARNING
 ⚠️ **WARNING:** Cancer and Reproductive Harm.
 ⚠️ **AVERTISSEMENT:** Peut Causer le Cancer et des Dommages au Système Reproducteur.
 ⚠️ **ADVERTENCIA:** Cáncer y Daño Reproductivo.
 www.p65warnings.ca.gov. #9.202114

Ordering Information

Product	Description	Carton Qty.	Carton Wt. (Lbs.)
ENERGY EFFICIENT FITTINGS			
178741	Sweep Elbow, PVC, White, 2-1/2 in. Socket, 3 in. Spigot. W=75	1	0.92
COMPLETE INSIDER WALL INLET FITTINGS FOR CONCRETE POOLS			
08428-0000	1-1/4 in. Slip, 3/16 in., 1/2 in., 3/4 in., 90° Nozzles, white	1	0.50
08429-0000	1-1/2 in. Slip, 3/16 in., 1/2 in., 3/4 in., 90° Nozzles, white	1	0.50
08428-0100	1-1/4 in. Slip, 3/16 in., 1/2 in., 3/4 in., 90° Nozzles, dark gray	1	0.50
08429-0100	1-1/2 in. Slip, 3/16 in., 1/2 in., 3/4 in., 90° Nozzles, dark gray	1	0.50
EYEBALL INSIDER INLET FITTINGS			
08434-0000	1-1/2 in. Slip, 1/2 in., 3/4 in., 90° Nozzles, white	1	0.50
08434-0100	1-1/2 in. Slip, 1/2 in., 3/4 in., 90° Nozzles, dark gray	1	0.50
VINYL POOL FITTINGS			
08430-0050	1-1/2 in. NPT body PVC, white	1	1.
08430-0000	1-1/2 in. Slip body PVC, white	1	1.
HYDROSTATIC RELIEF VALVE			
07017-0151	1-1/2 in. NPT hydrostatic valve		0.2
07017-0158	2 in. NPT hydrostatic valve		0.2
ALL PURPOSE PLUGS			
195830	2 in. plug with O-ring		100
552612	1-1/2 in. flush plug, white		100
552614	1-1/2 in. flush plug, black		100
552622	1-1/2 in. plug with O-ring, white		100
552624	1-1/2 in. plug with O-ring, black		100
SPECIAL EYEBALL FITTINGS			
86204200	Reducer adapter, 1-1/2 in. o.d. x 1 in. slip, 1 in., white	50	10
86204211	Reducer adapter, 1-1/2 in. o.d. x 1 in. slip, 1 in., black	50	10
86204215	Reducer adapter, 1-1/2 in. o.d. x 1 in. slip, 1 in., dark gray	50	10
JETS FOR CONCRETE INSTALLATION			
46540000	Venturi Jet, 5/16 in. nozzle, 1/2 in. socket air x 1-1/2 in. socket water, 1-1/2 in. socket return	40	20
46540100	Venturi Jet, 1/2 in. nozzle	40	20



Sweep Elbow, PVC

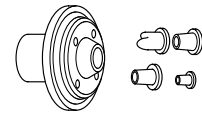

Wall Inlet Fittings



Eyeball Inlet Fittings



Hydrostatic Relief Valve



2 in. Plug with O-Ring



46540000



46550000



86204200



1-1/2 in. Plug with O-Ring

POOL SPECIALTY FITTINGS (CONT'D)



Vacuum Plug



86201500



Rope Hook



Valve Lid & Ring
ABS



542044



542142

Ordering Information

Product	Description	Carton Qty.	Carton Wt. (Lbs.)
FLOOR INLET FITTINGS			
08417-0000	2 in. Slip with 1-1/2 in. slip bushing, white ³	1	1
08417-0100	2 in. Slip with 1-1/2 in. slip bushing, gray ³	1	1
08417-0200	2 in. Slip with 1-1/2 in. slip bushing, black ³	1	1
SPECIAL FITTINGS			
46550000	Aerator Cap, 1-1/2 in. for air channel, white	50	13
46550015	Aerator Cap, 1-1/2 in. for air channel, dark gray	50	13
46550065	Aerator Cap, 1-1/2 in. for air channel, gray	50	13
510166	Hose adapter, straight, white ⁴	50	3
86201500	Aerator inlet (used as a return spray nozzle)	10	1
K12500	Snap Lock Kit Fitting	1	0.10
GW9530	Vac-port fitting, NSF listed	1	0.10
86200500	Vacuum or Winterizing plug with Oring	1	0.50
VALVE COVERS			
86300100	Valve Lid & Ring, ABS, 6 in., white	1	1
86300130	Valve Lid & Ring, ABS, 6 in., beige	1	1
GRATE INSERTS			
540056	Grate insert, 1-1/2 in. MIP, white ²	50	2
540057	Grate insert, 1-1/2 in. MIP, black ²	50	2
ROPE ANCHORS & HOOKS			
542044	Anchor Cup with SS bar, white ¹	100	24
542045	Anchor Cup with SS bar, black ¹	100	24
86201200	Anchor Cup, ABS, white	100	16
86201215	Anchor Cup, ABS dark gray	100	16
86201300	Anchor Cup, ABS with SS cross bar, white ¹	100	16
86201400	Rope Hook, 3/4 in., ABS	150	16
542142	Rope Hook for 3/4 in. rope with two SS screws	200	22
STEPS			
82400700	ABS Steps, set of three, white	1	3
82400800	ABS Steps, set of three, gray	1	3

¹ Not for use with saltwater pools.

² Not for use as a suction fitting.

³ Use only as a floor inlet fitting.

⁴ Hose to NPT fittings.

RETURN FITTINGS FOR SWIMMING POOLS

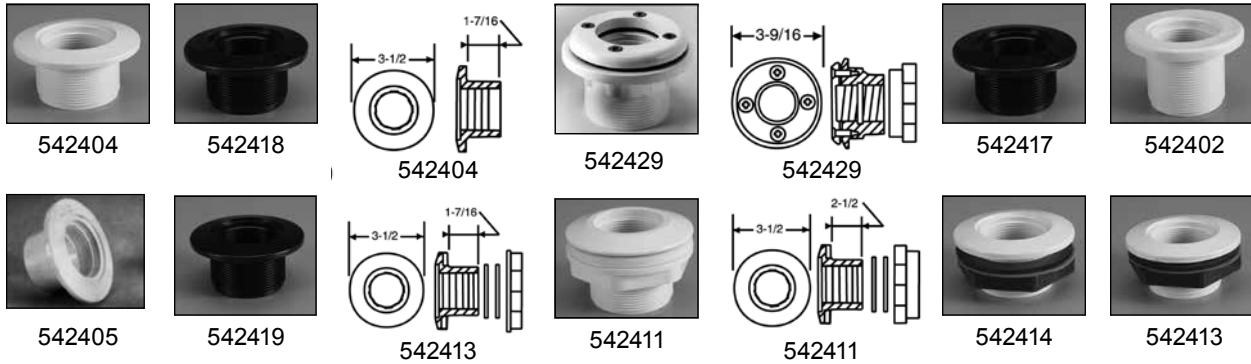

Ordering Information

Product	Description	Carton Qty.	Carton Wt. (Lbs.)
GUNITE/CONCRETE			
542402	Long body, 1-1/2 in. threaded x 1-1/2 in. socket, white	50	9
542417	Long body, 1-1/2 in. threaded x 1-1/2 in. socket, black	50	9
542404	Standard body, 1-1/2 in. threaded x 1-1/2 in. threaded, white	50	9
542405	Standard body, 1-1/2 in. threaded x 1-1/2 in. socket, white	50	9
542418	Standard body, 1-1/2 in. threaded x 1-1/2 in. threaded, black	50	9
542419	Standard body, 1-1/2 in. threaded x 1-1/2 in. socket, black	50	9
FIBERGLASS POOLS & SPAS ²			
542411	Long body, 1-1/2 in. threaded x 1-1/2 in. socket, spacer/locknut, white	50	9
542413	Standard body, 1-1/2 in. threaded x 1-1/2 in. threaded, spacer/locknut, white	50	9
542414	Standard body, 1-1/2 in. threaded x 1-1/2 in. socket, comb. spacer/locknut, white	50	9
CONCRETE-WALLED VINYL LINER POOLS ¹			
542429	Standard body, 1-1/2 in. threaded x 1-1/2 in. socket, white	50	9
VINYL LINER FITTINGS			
86205100	1-1/2 in. FIPT with screws, vinyl liner, white	50	25
86205101	1-1/2 in. FIPT with screws, vinyl liner, black	50	25
86205103	1-1/2 in. FIPT with screws, vinyl liner, dark gray	50	25
545100	Face plate for vinyl liner return fitting, white	50	10
545101	Face plate for vinyl liner return fitting, black	50	10
545103	Face plate for vinyl liner return fitting, dark gray	50	10
INSIDER FITTINGS FOR GUNITE/CONCRETE POOLS			
542423	2 in. slip body, for schedule 40 pvc pipe, white	50	7
542424	2 in. slip body, for schedule 40 pvc pipe, black	50	7

¹ Includes face plate, screws & gaskets.

² Includes back gaskets.



86205100

CALIFORNIA PROPOSITION 65 WARNING

⚠ **WARNING:** Cancer and Reproductive Harm.
 ⚠ **AVERTISSEMENT:** Peut Causer le Cancer et des Dommages au Système Reproducteur.
 ⚠ **ADVERTENCIA:** Cáncer y Daño Reproductivo.

www.p65warnings.ca.gov. FR 200714

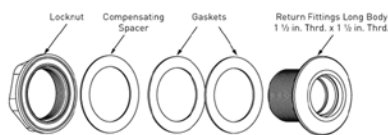

542411

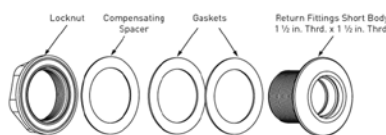

542413

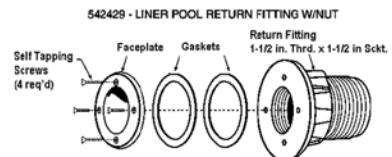

542429

WALL FITTINGS - INLETS



Directional eyeball inlets with 1-1/2 in. MIP thread to fit standard female adapter or wall fitting



Insider directional inlet wall fittings with 1/2, 3/4, 1 in. and slotted openings



Economy Insider 542000

CALIFORNIA PROPOSITION 65 WARNING
 ⚠️ **WARNING:** Cancer and Reproductive Harm.
 ⚠️ **AVERTISSEMENT:** Peut Causer le Cancer et des Dommages au Système Reproducteur.
 ⚠️ **ADVERTENCIA:** Cáncer y Daño Reproductivo.
www.p65warnings.ca.gov PH201714

Ordering Information

Product	Description	Carton Qty.
1-1/2 INCH THREADED DIRECTIONAL EYEBALLS		
542087	Ultimate eyeball 1-1/2 in. threaded with snap-in disks, 1/2 in., 3/4 in., 1 in., white	50
540000	Slotted opening, white	50
540001	Slotted opening, black	50
540002	Slotted opening, dark gray	50
540007	3/8 in. opening, white	50
540008	3/8 in. opening, black	50
540009	3/8 in. opening, dark gray	50
540014	1/2 in. opening, white	50
540015	1/2 in. opening, black	50
540016	1/2 in. opening, dark gray	50
540021Z	3/4 in. opening, white	50
540022	3/4 in. opening, black	50
540023	3/4 in. opening, dark gray	50
540028	1 in. opening, white	50
540029	1 in. opening, black	50
540030	1 in. opening, dark gray	50
ECONOMY INSIDER		
542000	1 in. slip inlet with snap-in 3/8 in., 3/4 in. and pressure test disks, white	300
542001	1 in. slip inlet with snap-in 3/8 in., 3/4 in. and pressure test disks, black	300
542002	1-1/2 in. slip inlet with snap-in 1/2 in., 3/4 in, 1 in., and pressure test disks, white	200
542003	1-1/2 in. slip inlet with snap-in 1/2 in., 3/4 in, 1 in., and pressure test disks, black	200
INSIDER DIRECTIONAL FITTINGS		
540035	1-1/2 in. slip inlet, 1/2 in., white	50
540036	1-1/2 in. slip inlet, 1/2 in., black	50
540037	1-1/2 in. slip inlet, 1/2 in., dark gray	50
540042	1-1/2 in. slip inlet, 3/4 in., white	50
540043	1-1/2 in. slip inlet, 3/4 in., black	50
540044	1-1/2 in. slip inlet, 3/4 in., dark gray	50
540049	1-1/2 in. slip inlet, 1 in., white	50
540050	1-1/2 in. slip inlet, 1 in., black	50
540051	1-1/2 in. slip inlet, 1 in., dark gray	50
540053	1-1/2 in. slip inlet, slot 1 in., white	50

AUTOMATIC WATER FILLERS

WATER LEVEL CONTROL



Automatic Water Fillers

CALIFORNIA PROPOSITION 65 WARNING
 ⚠️ **WARNING:** Cancer and Reproductive Harm.
 ⚠️ **AVERTISSEMENT:** Peut Causer le Cancer et des Dommages au Système Reproducteur.
 ⚠️ **ADVERTENCIA:** Cáncer y Daño Reproductivo.
 www.p65warnings.ca.gov. PA320714

Featured Highlights

- Available for standard in-ground and vanishing edge pools
- Helps prevent equipment damage due to low water levels
- No electronic controls
- Aids in the prevention of water waste and landscape damage due to overfilling pool
- Available with white, black, gray, and almond colored lids

Ordering Information

Product	Description
AUTOMATIC WATER FILLERS	
T40BBE	AutoFill w/ side mounted float valve, almond
T40BBK	AutoFill w/ side mounted float valve, black
T40BG	AutoFill w/ side mounted float valve, gray
T40BDG	AutoFill w/side mounted float valve, dark gray
T40BW	AutoFill w/ side mounted float valve, white
T40FB	AutoFill w/ Fluidmaster® valve, almond
T40FBK	AutoFill w/ Fluidmaster valve, black
T40FG	AutoFill w/ Fluidmaster valve, gray

Product	Description
T40FW	AutoFill w/ Fluidmaster valve, white
T40FDG	AutoFill 2/Fluidmaster valve, dark gray
T40FNB	AutoFill Vanishing Edge w/ Fluidmaster valve, almond
T40FNBK	AutoFill Vanishing Edge w/ Fluidmaster valve, black
T40FNG	AutoFill Vanishing Edge w/ Fluidmaster valve, gray
T40FNDG	AutoFill Vanishing Edge w/ Fluidmaster valve, dark gray
T40FNW	AutoFill Vanishing Edge w/ Fluidmaster valve, white

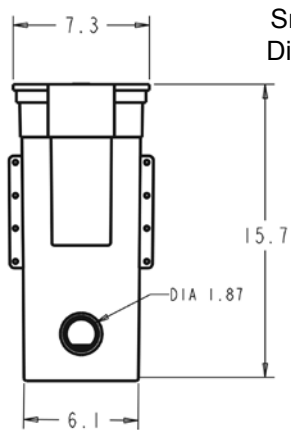

Small Filler Dimensions

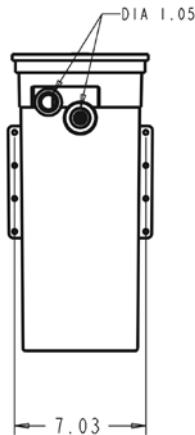

Fluidmaster Valve



Large Filler Dimensions

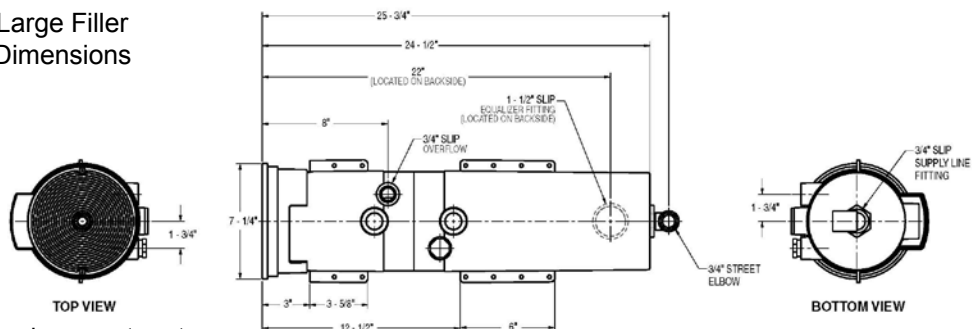

See page 600 for replacement parts.

INLINE THERMOMETERS FOR POOL AND SOLAR APPLICATIONS

CALIFORNIA PROPOSITION 65 WARNING
 ⚠️ **WARNING:** Cancer and Reproductive Harm.
 ⚠️ **AVERTISSEMENT:** Peut Causer le Cancer et des Dommages au Système Reproducteur.
 ⚠️ **ADVERTENCIA:** Cáncer y Daño Reproductivo.
 www.p65warnings.ca.gov. PN 202514

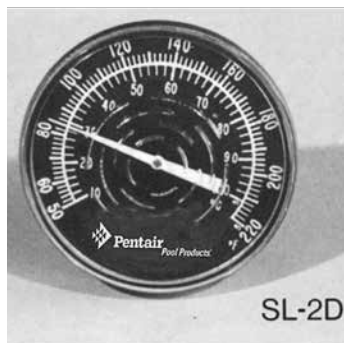

SL-2D



SL-2D

Ordering Information

Product	Description	Carton Qty.
INLINE THERMOMETER WELLS		
SWB	1/2 in. Brass well	1
SWB1	3/4 in. Brass well	1
SWN	Nylon well	1
INLINE THERMOMETER for Solar Applications		
SL2D	50/220°F. w/ 1/2 in. NPT (threaded)	1
SL2DW	50/220°F. w/ 1/2 in. Brass well	1
SL2DW3	50/220°F. w/ 3/4 in. Brass well	1
INLINE THERMOMETERS for Pool Applications		
SL1DW	30/130°F. w/ Nylon well	1

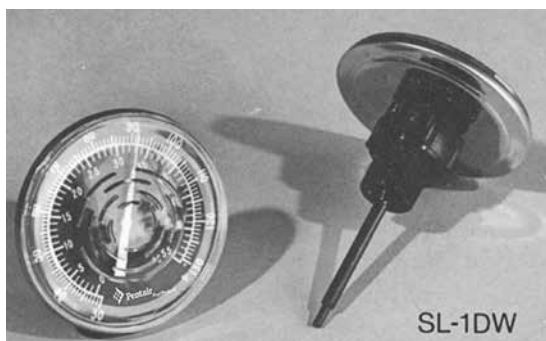

SL-1DW

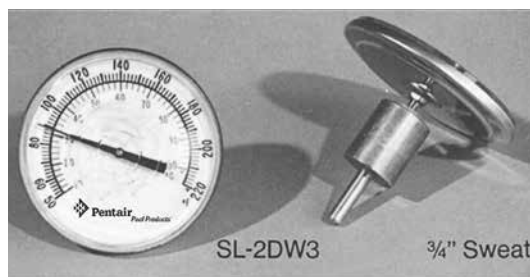

SL-2DW3

3/4" Sweat

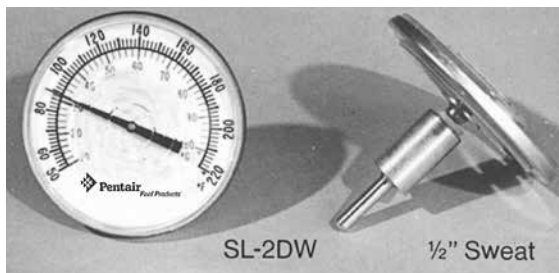

SL-2DW

1/2" Sweat

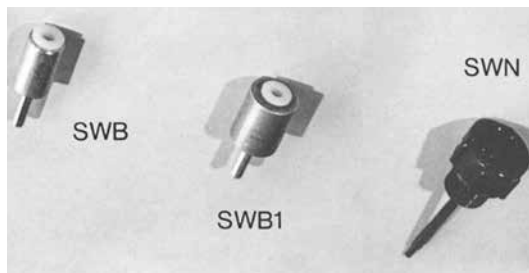

SWB

SWB1

SWN

FLOWMETERS

FOR COMMERCIAL AND INDUSTRIAL LIQUID APPLICATIONS



Flowmeter

Featured Highlights

- Stainless steel guide and floats
- Easy installation and maintenance; no tools required, tightens by hand
- Textured surface on back of meter for improved readability
- Easy to read GPM and LPM Scales
- Brass threaded knurled nuts for durability

CALIFORNIA PROPOSITION 65 WARNING

⚠ **WARNING:** Cancer and Reproductive Harm.
 ⚠ **AVERTISSEMENT:** Peut Causer le Cancer et des Dommages au Système Reproducteur.
 ⚠ **ADVERTENCIA:** Cáncer y Daño Reproductivo.
www.p65warnings.ca.gov

Ordering Information

Product	GPM	Description	Carton Qty.	Carton Wt. (Lbs.)
SMALL BODY FLOWMETERS				
LDF360B	1/2–5	3/4 in., Brass sweat end	1	1
LDF360N	1/2–5	3/4 in., Nylon threaded end	1	3/4
LDF360T	1/2–5	1 in., Brass threaded end	1	1-1/4
LDF357B	1–10	3/4 in., Brass sweat end	1	1
LDF357N	1–10	3/4 in., Nylon threaded end	1	3/4
LDF357T	1–10	1 in., Brass threaded end	1	1-1/4
LDF359B	2–16	3/4 in., Brass sweat end	1	1
LDF359N	2–16	3/4 in., Nylon threaded end	1	3/4
LDF359T	2–16	1 in., Brass threaded end	1	1-1/4
LARGE BODY FLOWMETERS				
LDF451B	8–75	1 in., Brass sweat end	1	1-1/4
LDF461T	8–75	1-1/2 in., Brass threaded end	1	1-1/2
LDF452B	15–100	1 in., Brass sweat end	1	1-1/4
LDF462T	15–100	1-1/2 in., Brass threaded end	1	1-1/2